

Beli Chan

Sales Manager

M: +86 139 2586 8276

WhatsApp: +86 139 2586 8276

E-mail: Beli@championbagmaker.com

MACHINERY MANUFACTURER OF **LUXURY PAPER BAGS**

CHAMPION MACHINERY MANUFACTURING CO.,LTD.

Add: 42#2and Longyan Industrial Avenue, Humen Town Dongguan City, China PR

Website: www.paper-bag-machine.com

CHAMPION
MACHINERY



Coffee Gong

Sales

M: +86 186 8118 5198

WhatsApp: +86 134 2327 5528

E-mail: sales8@championbagmaker.com

MACHINERY MANUFACTURER OF **LUXURY PAPER BAGS**

CHAMPION MACHINERY MANUFACTURING CO.,LTD.

Add: 42#2and Longyan Industrial Avenue, Humen Town Dongguan City, China PR

Website: www.paper-bag-machine.com

CHAMPION
MACHINERY

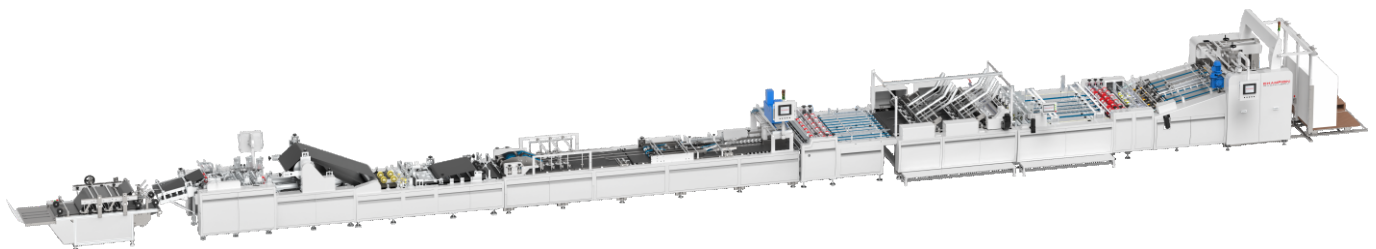

CM2SP-1400TFC + CMBF-520A

Double Sheets Pasting Paper Bag Machine
With Auto 4 PCS Top Cardboard Production Line

双拼纸袋自动生产线（带头卡选配）

目录

Contents

机器名称图片 Machine Name Image	3
工艺流程图 Process Flowchart	3
机器说明 Machine Description	4
机器特点 Machine Features	4
参数示意图 Sheet Paper Data	5
主要技术参数 Technical Data	6
设备占地规划 Machine Floor Plan	6
核心配件 Core Accessories	7

CM2SP-1400TFC + CMBF-520A

Double Sheets Pasting Paper Bag Machine
With Auto 4 PCS Top Cardboard Production Line

双拼纸袋自动生产线（带头卡选配）

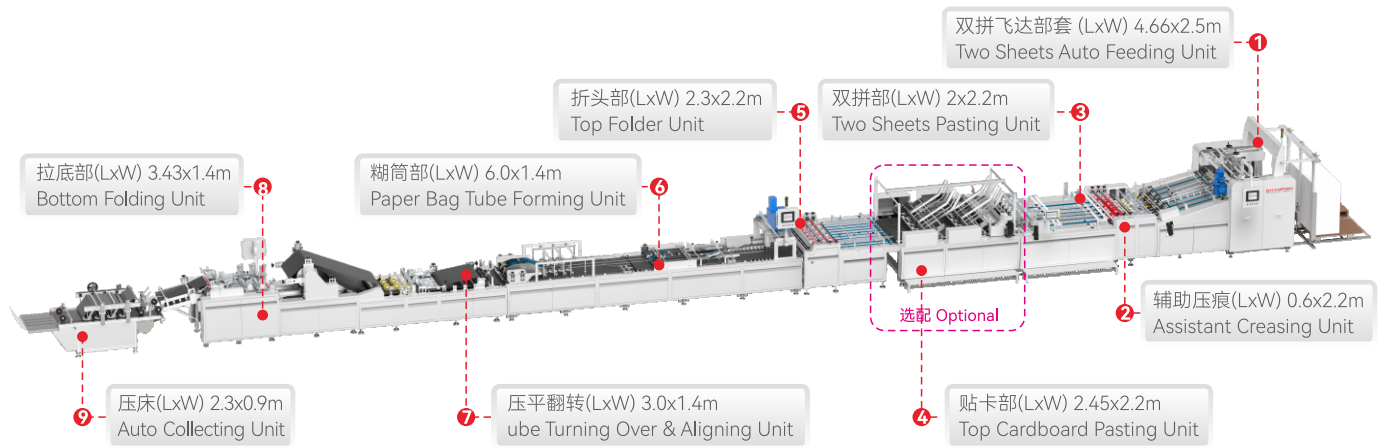

工艺流程图 Process Flowchart

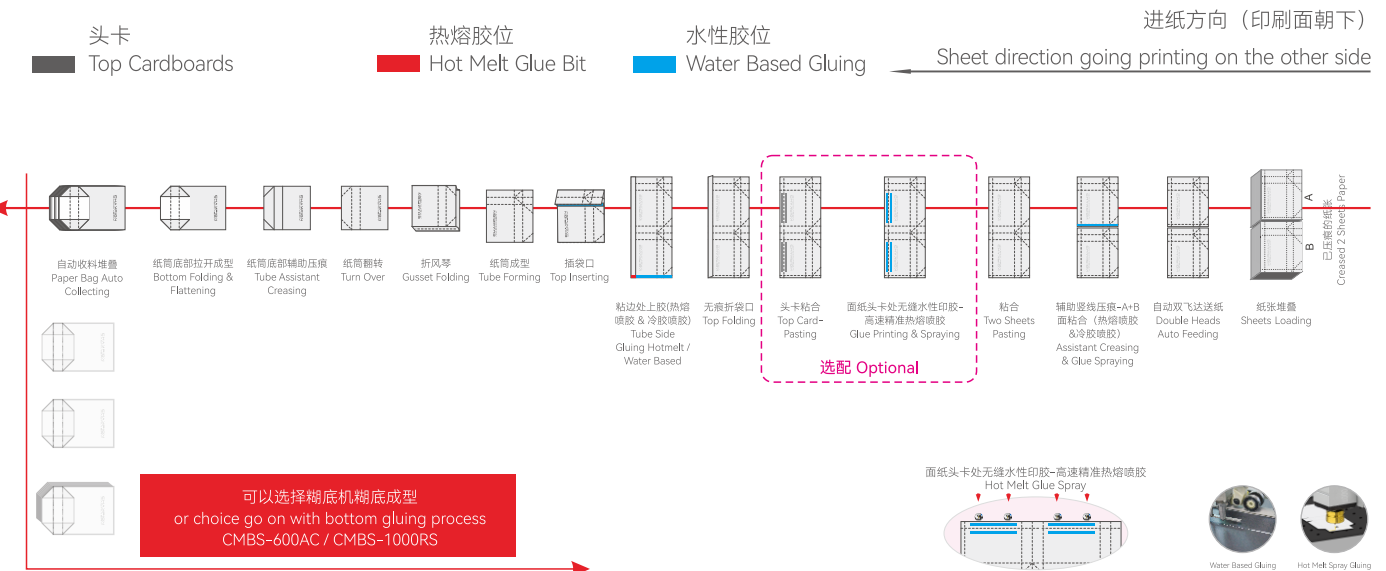



机器说明 Machine Description

该设备为自动双拼糊筒机，是一款集高效自动化的纸袋糊筒生产设备，专为满足双拼结构纸袋糊筒的生产需求而设计。该设备凭借其广泛的应用领域，如奢侈品、服装、礼品及购物纸袋等，展现了强大的市场适应性。

通过采用双拼成型技术，高速、高精度生产工艺以及智能化控制系统，实现降低成本、提升效率和优化质量。其模块化设计理念使得设备能够灵活应对不同生产需求，同时环保特性也符合当前绿色生产的趋势，成为传统纸袋生产设备升级换代的首选方案。

This automatic double-joint tube gluing machine is a highly efficient and automated paper bag tube gluing machine designed specifically to meet the production needs of double-joint structure paper bags. This machine demonstrates strong market adaptability through its wide range of applications, including luxury goods, clothing, gifts, and shopping paper bags.

By utilizing double-joint forming technology, high-speed, high-precision production processes, and an intelligent control system, it reduces costs, improves efficiency, and optimizes quality. Its modular design allows for flexible adaptation to diverse production needs. Its environmentally friendly features align with current trends in green production, making it a leading upgrade option for traditional paper bag production equipment.



机器特点 Machine Features

- 1. 拼接技术:** 采用自主研发的双拼技术，确保纸袋尺寸精准，成型良好。可将两张较小尺寸的纸袋拼接成一个大尺寸的纸袋，无需额外购买大型设备和材料，大幅降低生产成本和投资。
 - 2. 高效自动化:** 该设备实现了全自动化操作流程，从原材料到成品袋一次性完成生产过程，包括自动拼袋、贴头卡、成筒、折风琴、拉底、成品袋整理等。
 - 3. 智能控制:** 主控电路采用进口单片机，人机界面，变频控制，参数设定方便快捷，操作集中直观，完全实现人性化的全自动运行控制。数字化故障自诊断功能，故障诊断一目了然，方便快速维护和调整。
 - 4. 降低人工成本:** 自动化程度高，只需一人即可完成整个生产流程，可减少3-5人的人工成本及中间搬运环节。简单易学，节省人工成本，更加人性化。
 - 5. 耐用维护便捷:** 双变频设计，机械结构简洁，磨损小，维护方便，使用寿命长。
 - 6. 关键部件:** 整机核心部件均采用知名品牌，性能稳定、高效耐用。
 - 7. 环保材料:** 粘合工艺多采用环保水性胶和热熔胶，符合食品包装安全标准，设备结构便于清洁维护，减少废弃物产生。
 - 8. 材料适应:** 支持多种纸张材质（120-350g/m²），包括牛皮纸、白卡纸、铜版纸等。
- 1. Splicing Technology:** Utilizing independently developed double-splicing technology, the machine ensures precise paper bag dimensions and precise shaping. It can splice two smaller paper bags into one large one, eliminating the need for additional large-scale equipment and materials, significantly reducing production costs and investment.
 - 2. Efficient Automation:** This machine features a fully automated process, completing the entire production process from raw materials to finished bags, including automatic bag splicing, header card application, tube forming, accordion folding, bottom pulling and finished bag finishing.
 - 3. Intelligent Control:** The main control circuit utilizes an imported single-chip microcomputer, a human-machine interface, and variable frequency control. Parameter setting is quick and easy, and operation is centralized and intuitive, achieving fully user-friendly, fully automatic operation. Digital fault self-diagnosis provides clear fault diagnosis at a glance, facilitating quick and easy maintenance and adjustments.
 - 4. Reduced Labor Costs:** With a high degree of automation, the entire production process can be completed by only one person, eliminating 3-5 labor costs and intermediate handling steps. Easy to learn, it saves labor costs and offers a more user-friendly experience.
 - 5. Durability and Easy Maintenance:** The dual-frequency design features a simple mechanical structure, minimal wear, easy maintenance, and a long service life.
 - 6. Key Components:** All core components of the entire machine utilize renowned brands, ensuring stable performance, high efficiency, and exceptional durability.
 - 7. Environmentally Friendly Materials:** The bonding process primarily utilizes environmentally friendly water-based and hot-melt adhesives, meeting food packaging safety standards. The machine structure is easy to clean and maintain, reducing waste generation.
 - 8. Material Compatibility:** Supports a variety of paper materials (120-350g/m²), including kraft paper, white cardboard, and coated paper.



参数示意图 Sheet Paper Data

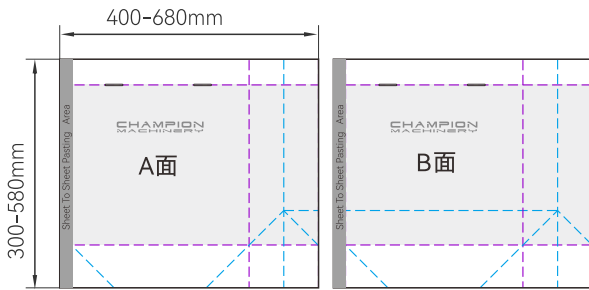
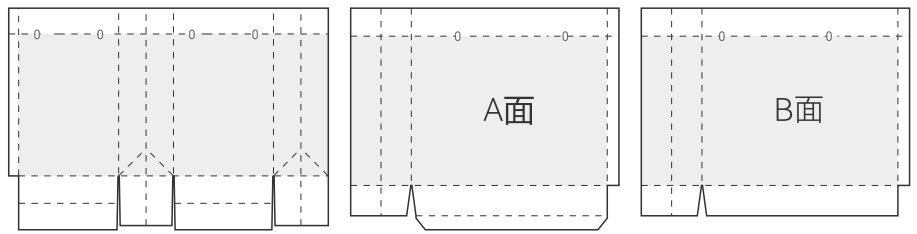
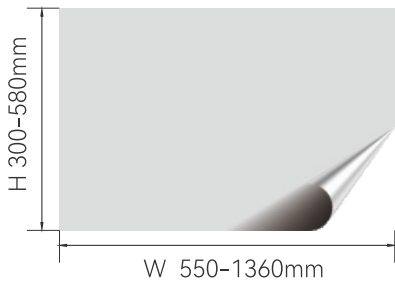

Before Pasting

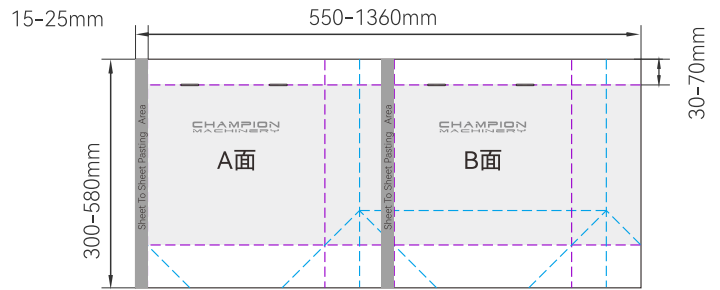

After Pasting

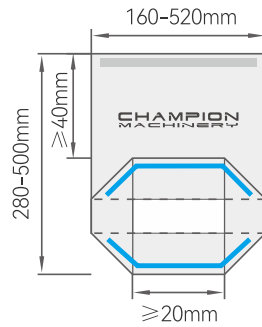
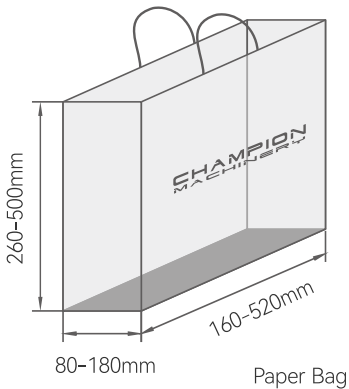

Type Bag Bottom (1)

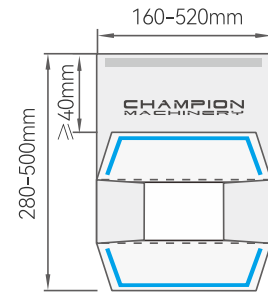

Type Bag Bottom (2)

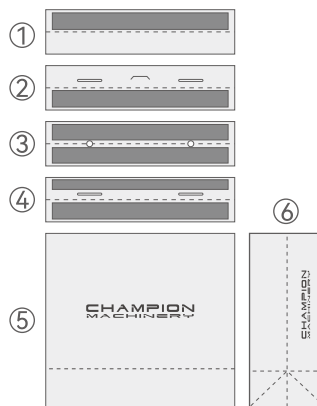
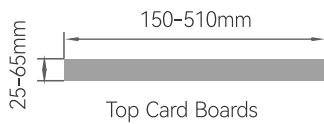

- 1、纸板高于折叠线的位置
Position above top folding line
- 2、纸板位于折叠线以下
Position below top folding line
- 3、顶部粘贴4张相同尺寸的纸板
Top cardboard pasting 4 pcs same size
- 4、顶部粘贴4张不同尺寸的纸板
Top cardboard pasting 4 pcs different size
- 5、纸袋
Paper bag body
- 6、纸袋风琴
Paper bag gusset



主要技术参数 TechnicalData

纸张尺寸 Sheet Paper Size		
W进纸宽度范围	Sheet Paper Width	550-1360mm
H进纸长度范围	Sheet Paper Length	300-580mm
双拼纸尺寸 Two Sheet Paper Size		
W1进纸宽度范围	Before Pasting Sheet Paper Width 1	400-680mm
W2进纸宽度范围	Before Pasting Sheet Paper Width 2	400-680mm
W进纸宽度范围	After Pasted W1+w2 Sheet Paper Width	550-1360mm
H进纸长度范围	Sheet Paper Length	300-580mm
纸筒尺寸 Paper Bag Tube Size		
折袋口尺寸	Paper Bag Top Folder Depth	30-70mm
纸筒宽度	Paper Bag Tube Width	160-500mm
纸筒长度	Paper Bag Tube Length	260-550mm
风琴尺寸	Paper Bag Gusset	80-180mm
粘位尺寸	Sheet Paper Glue Side	15-25mm
适用纸张原材料和耗材 Suitable Paper Material & Glue & Handle		
牛皮纸	Kraft Paper	120-350gsm
铜版纸/覆膜纸	Coat Paper / Laminated	157-250gsm
白卡纸	White Board Paper	157-300gsm
灰板纸	Grey Board Paper	157-300gsm
胶水	Glue	标配热熔选配胶水溶性冷胶 Hot melt glue option water base glue
手提绳	Handle	纸手腕圆/扁, 贴丝带, 打头手提绳子/丝带 其他 Flat paper handle, twisted paper handle, tipping with rope or ribbon handle, Ribbon handles with top cardboard pasting glue fix of luxury paper bag
头卡 Top Cardboards		
头卡宽度	Top Cardboards Width	25-65mm
头卡长度	Top Cardboards Length	150-510mm
头卡克重	Top Cardboards Thickness	200-400gsm 4pcs / 200-600gsm 2 pcs
运行 Running		
速度	Speed	0-60 pcs/min
安装要求 Installation		
装机总功率	Total Power Supply	39KW
压缩空气	Compressed Air / Capacity	6bar
储气罐能量	Air Tank Capacity	15m ³ /h



设备占地规划 Machine Floor Plan

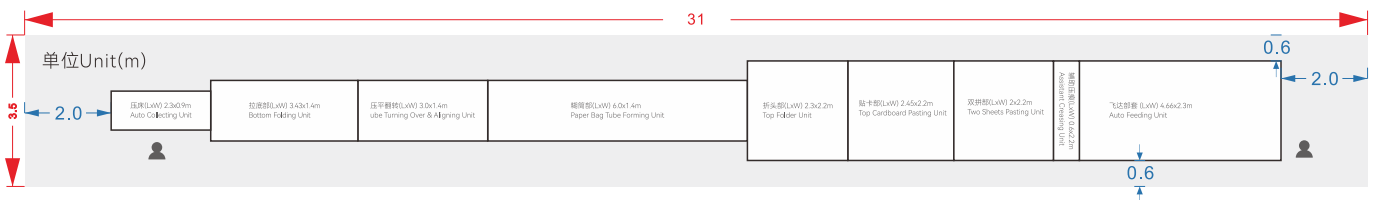



核心配件 Core Accessories



SynMatic

运动控制系统
伺服电机/伺服驱动/变频器
SIMOTION
Servo motor/servo drive/frequency converter

安驰 中国
SynMatic China



KEYENCE

总线控制
BUS CONTROL

基恩士 日本
Keyence Nippon



Honeywell

编码器/接近开关
热过载继电器接触器
ENCODER/PROXIMITY SWITCH
Thermal overload relay contactor

霍尼韦尔 美国
Honeywell US



KEYENCE

主光电眼/光纤
MAIN OPTICAL EYE/FIBER

基恩士 日本
Keyence Nippon



触摸屏
TOUCH SCREEN

威伦 台湾
WEINVIEW Taiwan



MAC

电磁阀
SOLENOID VALVE

MAC 美国
MAC US



CPG

减速机马达
REDUCER MOTOR

晟邦 台湾
Shengbang CPG Taiwan



SIEMENS

主马达
MAIN MOTOR

西门子贝德 德国
Siemens Bader Germany



ORION

真空泵
VACUUM PUMP

好利旺 日本
ORION Japan